



SUP-212



Rev 01/2024

MAX 75 KG

Brand & Model  

MERCEDES R CLASS (W251)	5	2005-2013
MERCEDES S CLASS (W221)	4	2005-2013
MERCEDES CLS (C219)	4	2004-2010
MERCEDES CLS (C218)	4	2010-2018
M. CLS SHOOTING BRAKE (X218)	4	2011-2018
MERCEDES GLE COUPE (C292)	5	2015-2019

We do not recommend the use of rooftop tents with these roof bars

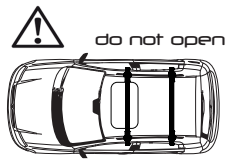
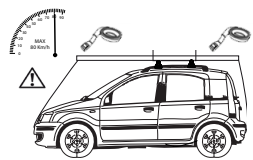
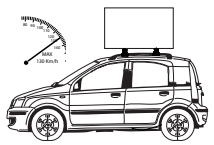
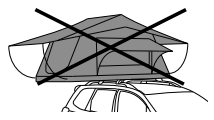
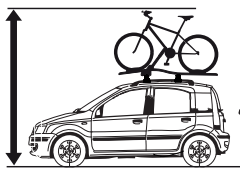
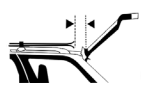
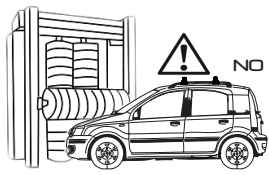

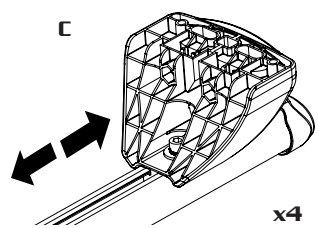
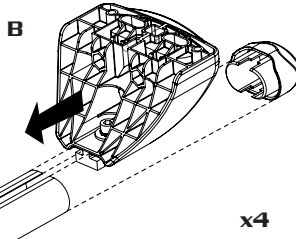
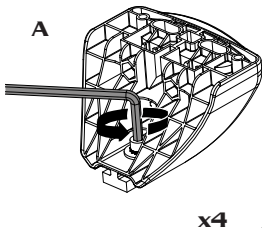
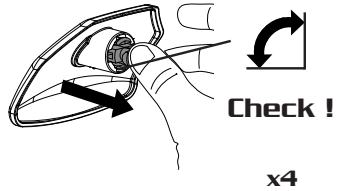
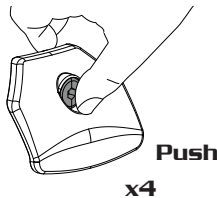
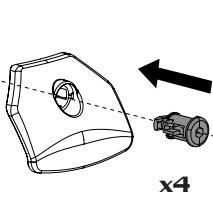
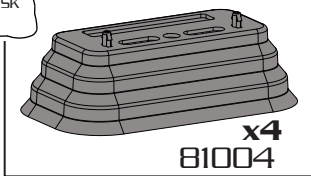
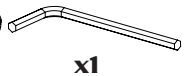
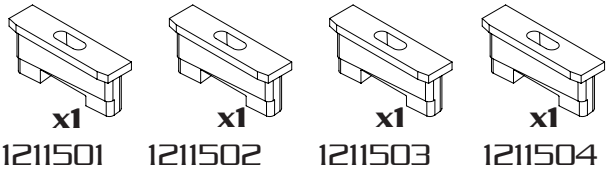
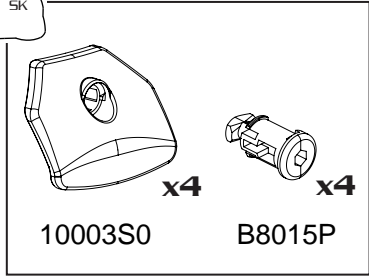
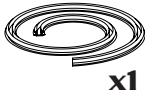
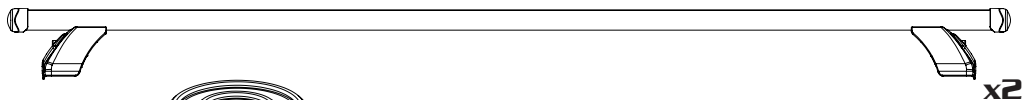

in caso di piedi pre montati saltare le fasi A e B - in case of pre-assembled feet skip phases A and B -
 en cas de pieds pré-montés, sauter les phases A et B - im Falle vormontierter FüÙe die Phasen A und B
 überspringen - En el caso de los pies pre-montados saltan las fases A y B

CONFIG. 1

GLE COUPE (C292)

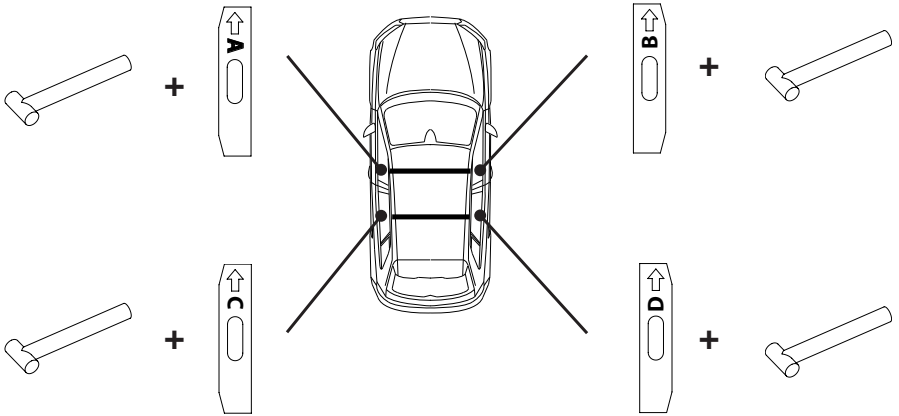

YOU MUST FOLLOW THE SPECIFICATION CONFIGURATION FOR YOUR VEHICLE!

CONFIG. 3

S CLASS (W221) - CLS (C218) - CLS SHOOTING BRAKE (X218)

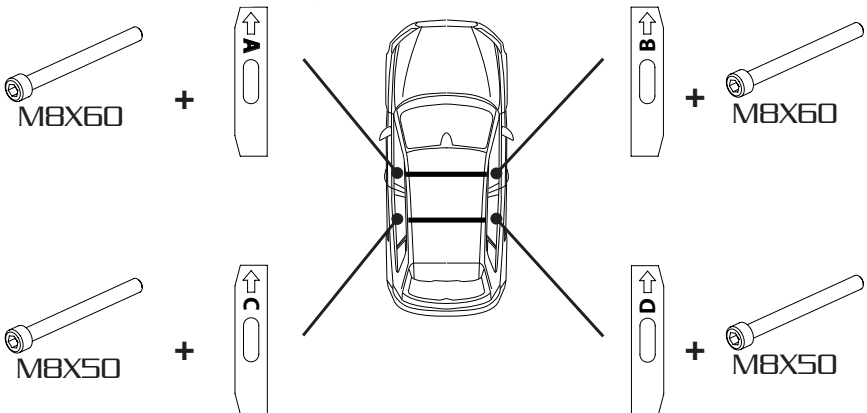

CONFIG. 4

CLS (C219)

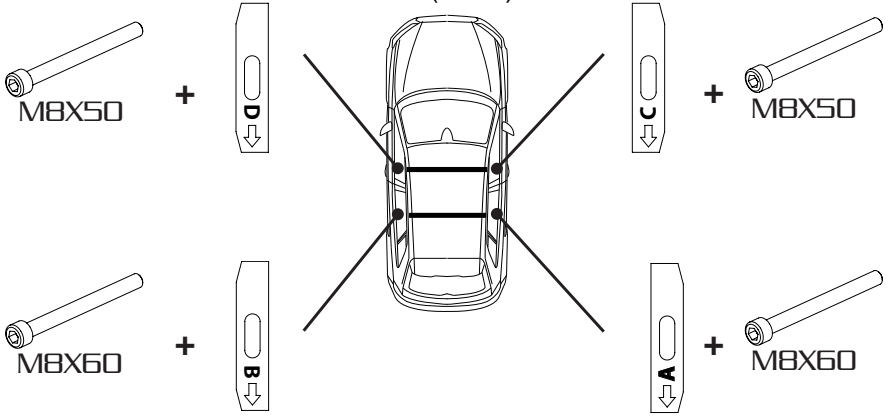

CONFIG. 5

R CLASS (W251)

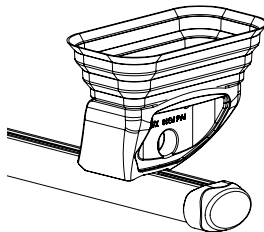
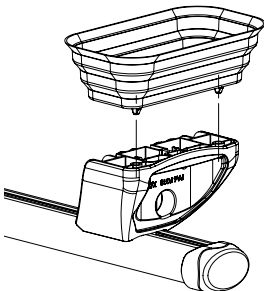
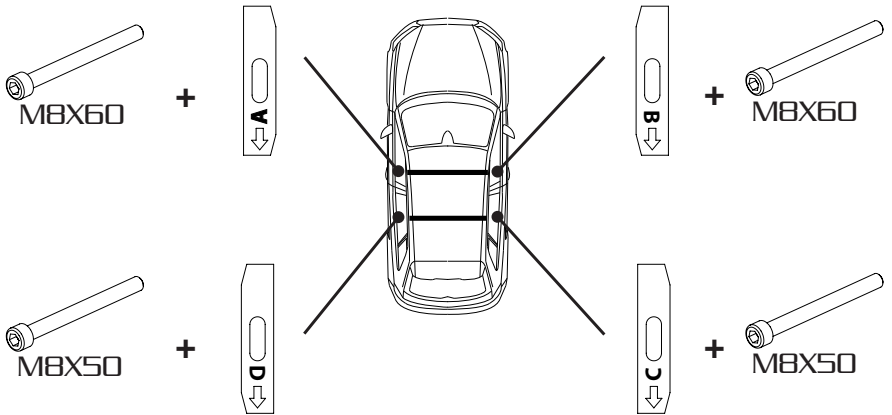

ONLY FOR CONFIG. 1

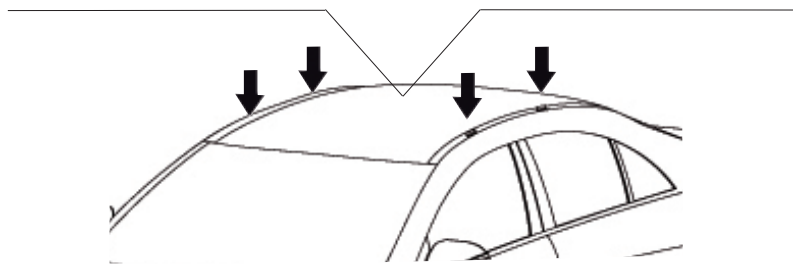
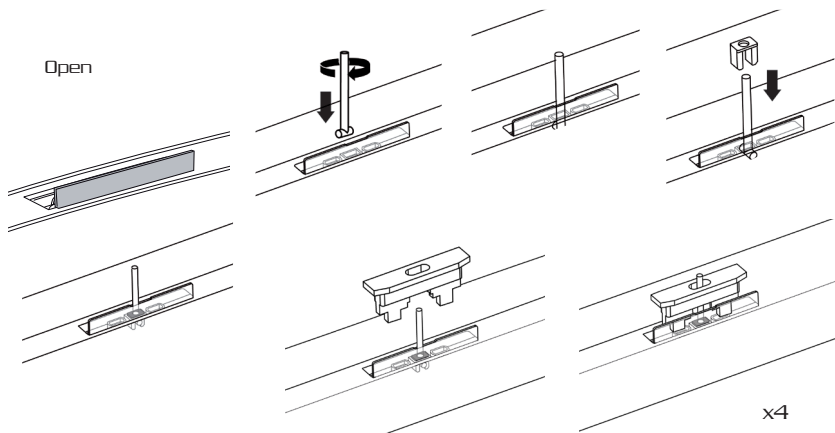

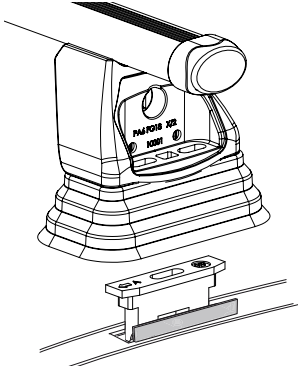
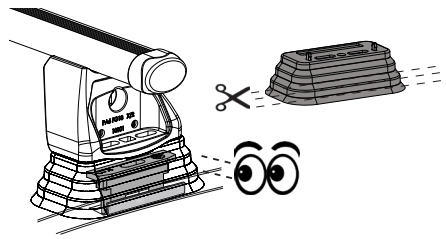
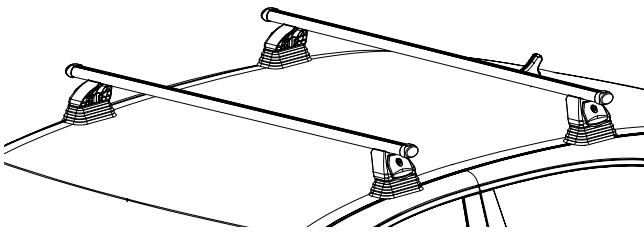

Specific for
CONFIG 1

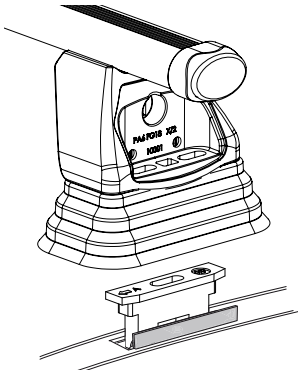
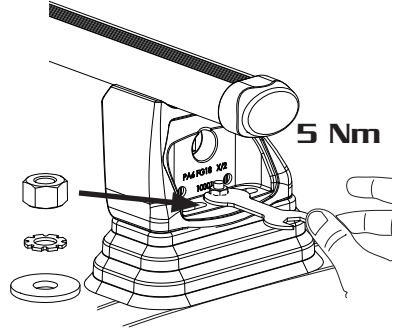

Specific for
CONFIG. 3 / CONFIG. 4 /
CONFIG. 5

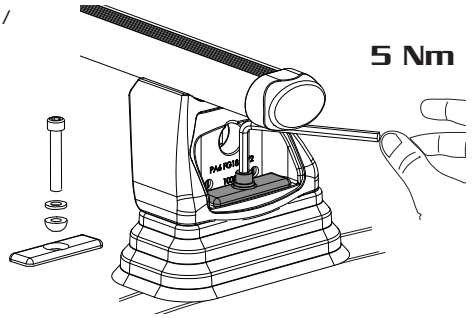

5 Nm

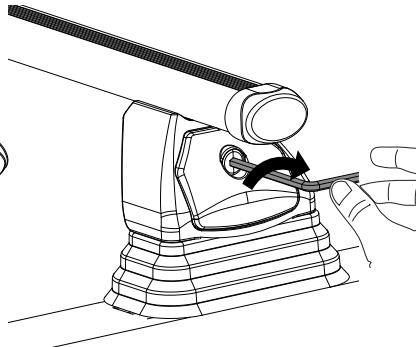
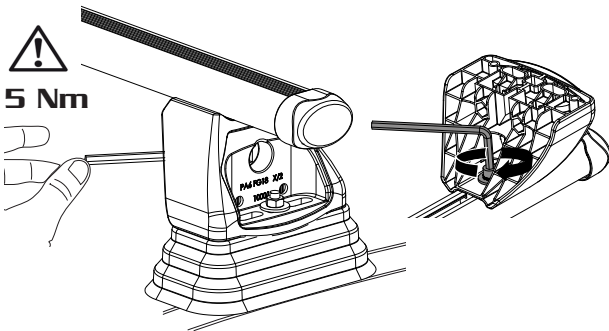

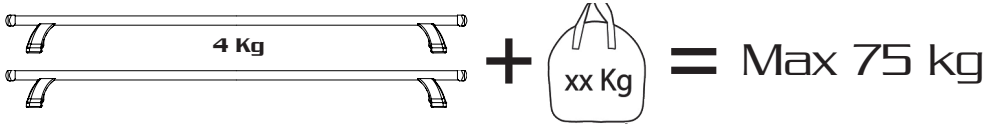
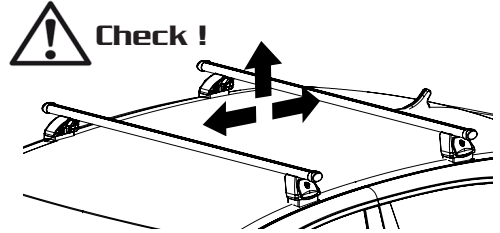
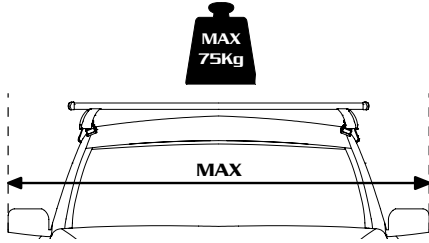
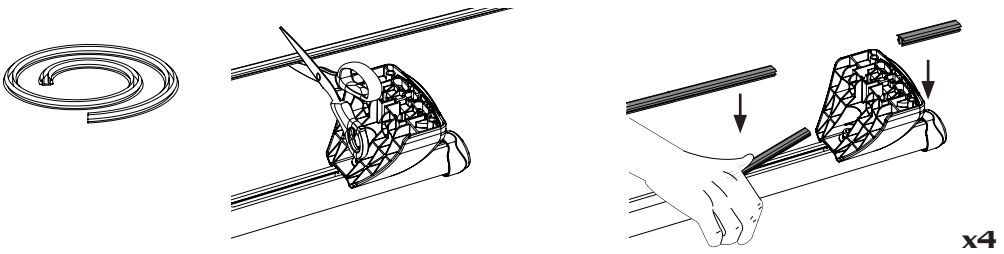

FR: Ne pas dépasser le poids total autorisé en charge (PTAC) sur le toit du véhicule.

EN: Not exceed the total weight permitted on the vehicle roof

ES: No debe sobrepasarse el peso total permitido sul techo del vehiculo motorizado

IT: Non superare il peso complessivo ammesso sul tetto del veicolo

DE: Das zulässige Gesamtgewicht des Kraftfahrzeuges darf nicht überschritten werden

FR: contrôle périodique à chaque voyage et à certains kilomètres parcourus.

EN: Periodical check at each trip and at certain Km travelled.

ES: control periódico en cada viaje y en ciertos Km recorridos.

IT: controllo periodico ad ogni viaggio e a determinati Km percorsi.

DE: periodische controle bei jeder reise und in bestimm ten Km.

FR: Pour le démontage réaliser a l'inversement ces étapes

EN: For disassembly perform these steps in reverse

ES: Para desmontar siga estos pasos a la inversa

IT: Per rimuovere le barre seguire le fasi al contrario

DE: Zu zerlegen diese Schritte in umgekehrter.

Installation Notes:

- Fit the roof bars according to the instructions only. Do not assemble or use this product unless you have understood the fitting instructions. Check with the instruction manual that all the necessary parts are included.
- Check and make sure that all fastening parts are fixed securely. Please check also that the load is fastened properly by pushing and pulling it. Recheck regularly.

Important Safety Notes:

- Please retain these instructions safely with your car owners manual, for future reference.
- The maximum permissible load evenly distributed over the full width of the bar with a low centre of gravity is 75kg (including the weight of the bars, 4kg). Check the vehicle handbook for fixing location for the roof bar and the maximum permitted load. The maximum permitted roof load must be the lowest quoted figure. And if the vehicle hand book states a maximum of less than 75kg, then that is the maximum permissible load. Even if the vehicle handbook states a maximum of 120kg, the maximum permissible load for these roofbars is 75kg.
- It is your responsibility to ensure that all loads are correctly and safely secured using suitable fixing methods (e.g. strong webbing straps with buckles). Where specialised accessories are available, they should be used (e.g. Cycle Carriers, Ski Holders, etc). If small heavy loads are being carried, load to one side of the bar, not the middle. Never attach loads to roof bars using bungee cords or elasticated straps.
- Before driving and at regular intervals during your journey, check that all securing screws, clamping devices and foot attachments are fully tightened, in accordance with these instructions. Additionally ensure the load is fastened correctly.
- After covering a short distance, all securing devices of both the load and the load carrier must be checked and tightened as required. This must be done at suitable intervals, depending on the nature of the road.
- To prevent damage or discolouration to the paint under the foot pack rubber, we recommend the cleaning of the load bar feet and the vehicle roof prior to fitment. The load bar should be removed at regular intervals to repeat this process.
- Neither the roof bars nor load must project beyond the maximum profile of the vehicle.
- Take care not to drive into low places such as garages or multi-storey carparks when carrying a high load, particularly cycles. Do not drive through an automatic car wash with the load carrier mounted on the vehicle. **When carrying long loads take care when opening the boot to not hit the boot lid onto the load.**

- Please note that some antennas and sunroofs can interfere with the roof bars or accessory when installed and should not be used, if so.
- Follow the instructions thoroughly and do not jump ahead in the sequence (1,2,3, A,B,C... etc).

• Using the bars, especially when carrying a load, will affect the driving and braking characteristics of your car. Larger roof loads may also affect your car's sensitivity to cross winds. For safety reasons, the vehicle must not be driven at maximum speeds.

Speed should be matched to the load being transported, to prevailing conditions including the state of the road, the quality of the road surface, the volume of traffic, etc., and of course any speed restrictions in force. Where there are no restrictions in force, we recommend a maximum speed of 65 mph, but the vehicle speed when transporting a load of any kind must be matched to the prevailing conditions.

• Surfboards, boats and large flat objects may produce damaging aerodynamic forces to the vehicle, out of all proportion to their dead weight. We therefore recommend travelling at much reduced speed when carrying these articles. **Where two or more surfboards are carried (or similar items which may produce lifting forces) they should not be carried side by side, but should be stacked one upon the other. They should be secured independently to the front and rear of the vehicle using strap or methods which are capable of withstanding the lifting forces.**

• **When carrying kayaks or canoes ensure that they are secured to the bars and also the front and rear of the vehicle in the upright position.**

• The roof bars must be kept clean and properly maintained, particularly during the winter months when dirt and salt must be removed. Bolts, screws and nuts should be lubricated at suitable intervals, the periodic use of a spray lubricant will keep any lock barrels working freely.

• Always fit the roof bars in accordance with these instructions. The spacing between the front and rear bars must never be less than 700 mm, except where the vehicle mountings determine the spacing.

IMPORTANT: This load carrier is especially designed for your car model. Please therefore check which type of load carrier is needed when changing your car. Do not use spare parts from other products. Do not put the car through an automatic car wash when the load carrier is mounted. The manufacturer takes no responsibility for damage caused by an incorrectly fitted load carrier.

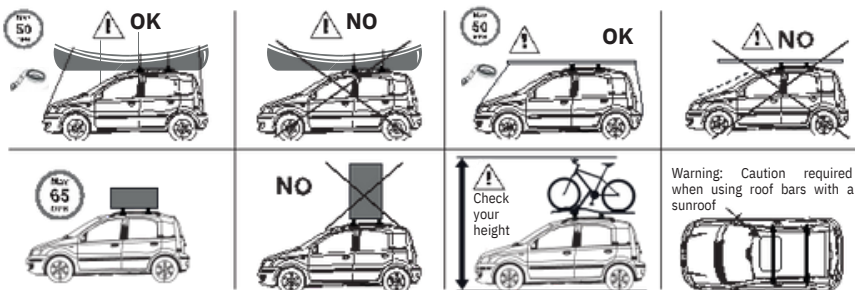

Made in the EU

Mountney Ltd, MXL Centre, Lombard Way, Banbury, Oxfordshire, OX16 4TJ.

Visit us at: www.mountneyltd.com info@mountneyltd.com